

MAX253

Transformer Driver for Isolated RS-485 Interface

General Description

The MAX253 monolithic oscillator/power-driver is specifically designed to provide isolated power for an isolated RS-485 or RS-232 data interface. The device drives a center-tapped transformer primary from a 5V or 3.3V DC power supply. The secondary can be wound to provide any isolated voltage needed at power levels up to 1W.

The MAX253 consists of a CMOS oscillator driving a pair of N-channel power switches. The oscillator runs at double the output frequency, driving a toggle flip-flop to ensure 50% duty cycle to each of the switches. Internal delays are arranged to ensure break-before-make action between the two switches.

The SD pin puts the entire device into a low-power shutdown state, disabling both the power switches and oscillator.

Applications

- Isolated RS-485/RS-232 Power-Supply Transformer Driver
- High Noise-Immunity Communications Interface
- Isolated and/or High-Voltage Power Supplies
- Bridge Ground Differentials
- Medical Equipment
- Process Control

Benefits and Features

- Simple Power-Supply Transformer Driver Design for Isolated RS-485/RS-232 Data-Interface Applications
 - Single 5V or 3.3V Supply
 - Low-Current Shutdown Mode: 0.4µA
 - Pin-Selectable Frequency: 350kHz or 200kHz
- 8-Pin DIP, SO, and µMAX® Packages Take Minimal Board Space

Ordering Information

PART	TEMP RANGE	PIN-PACKAGE
MAX253CPA	0°C to +70°C	8 Plastic DIP
MAX253CSA	0°C to +70°C	8 SO
MAX253CUA	0°C to +70°C	8 µMAX
MAX253C/D	0°C to +70°C	Dice*
MAX253EPA	-40°C to +85°C	8 Plastic DIP
MAX253ESA	-40°C to +85°C	8 SO
MAX253ESA/V	-40°C to +85°C	8 SO
MAX253MJA	-55°C to +125°C	8 CERDIP**

*Contact factory for dice specifications.

**Contact factory for availability and processing to MIL-STD-883. Devices are also available in a lead(Pb)-free/RoHS-compliant package. Specify lead-free by adding a (+) to the part number when ordering.

/V Denotes an automotive qualified part.

Typical Operating Circuit

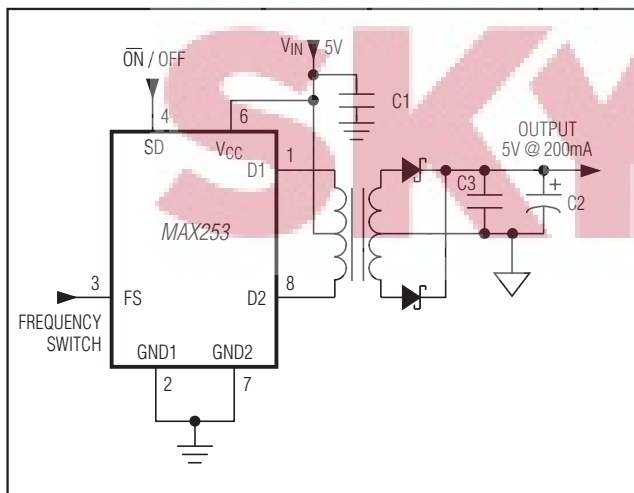

µMAX is a registered trademark of Maxim Integrated Products, Inc.

Absolute Maximum Ratings

Supply Voltage (V_{CC})	-0.3V to +7V
Control Input Voltages (SD, FS)	-0.3V to ($V_{CC} + 0.3V$)
Output Switch Voltage (D1, D2)	12V
Peak Output Switch Current (D1, D2)	1A
Average Output Switch Current (D1, D2)	200mA
Continuous Power Dissipation ($T_A = +70^\circ\text{C}$)	
Plastic DIP (derate 9.09mW/ $^\circ\text{C}$ above $+70^\circ\text{C}$)	727mW
SO (derate 5.88mW/ $^\circ\text{C}$ above $+70^\circ\text{C}$)	471mW
μMAX (derate 4.10mW/ $^\circ\text{C}$ above $+70^\circ\text{C}$)	330mW
CERDIP (derate 8.00mW/ $^\circ\text{C}$ above $+70^\circ\text{C}$)	640mW

Operating Temperature Ranges

MAX253C_/_E_	0 $^\circ\text{C}$ to +70 $^\circ\text{C}$
MAX253E_	-40 $^\circ\text{C}$ to +85 $^\circ\text{C}$
MAX253MJA	-55 $^\circ\text{C}$ to +125 $^\circ\text{C}$

Junction Temperatures

MAX253C_/_E_	+150 $^\circ\text{C}$
MAX253MJA	+175 $^\circ\text{C}$

Storage Temperature Range-65 $^\circ\text{C}$ to +160 $^\circ\text{C}$

Lead Temperature (soldering, 10s)+300 $^\circ\text{C}$

Soldering Temperature (reflow)

PDIP, SO, μMAX lead(Pb)-free	+260 $^\circ\text{C}$
PDIP, SO, μMAX , CERDIP containing lead(Pb)	+240 $^\circ\text{C}$

Stresses beyond those listed under "Absolute Maximum Ratings" may cause permanent damage to the device. These are stress ratings only, and functional operation of the device at these or any other conditions beyond those indicated in the operational sections of the specifications is not implied. Exposure to absolute maximum rating conditions for extended periods may affect device reliability.

Electrical Characteristics

($V_{CC} = 5V \pm 10\%$, $T_A = T_{MIN}$ to T_{MAX} , unless otherwise noted. Typical values are at $T_A = +25^\circ\text{C}$.)

PARAMETER	CONDITIONS	MIN	TYP	MAX	UNITS
Switch On-Resistance	D1, D2; 100mA		1.5	4.0	Ω
Switch Frequency	FS = V_{CC} or open	250	350	500	kHz
	$V_{FS} = 0V$	150	200	300	
Operating Supply Current (Note 1)	No load, $V_{SD} = 0V$, FS low		0.45	5.0	mA
Shutdown Supply Current (Note 2)	SD = V_{CC}		0.4		μA
Shutdown Input Threshold	High	2.4			V
	Low			0.8	μA
Shutdown Input Leakage Current			10		pA
FS Input Threshold	High	2.4			V
	Low			0.8	
FS Input Leakage Current	$V_{FS} = 0V$			50	μA
	FS = V_{CC}		10		pA
Start-Up Voltage		2.5	2.2		V

Note 1: Operating supply current is the current used by the MAX253 only, not including load current.

Note 2: Shutdown supply current includes output switch-leakage currents.

Typical Operating Characteristics

(Circuit of Figure 6, $V_{IN} = 5V \pm 10\%$, $T_A = +25^\circ C$, unless otherwise noted.)

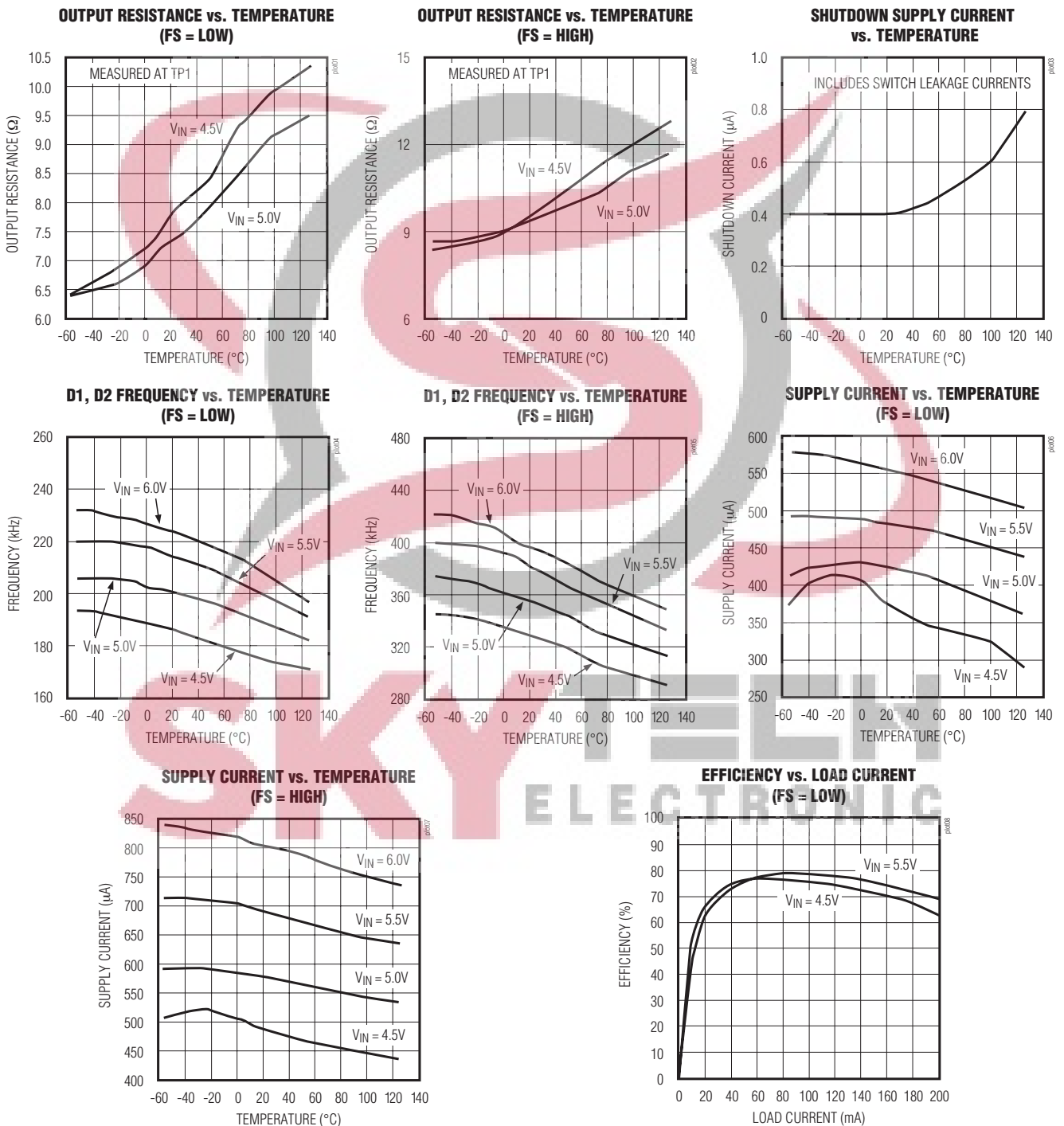

Typical Operating Characteristics (continued)

Circuit of Figure 6, $V_{IN} = 5V \pm 10\%$, $T_A = +25^\circ C$, unless otherwise noted.)

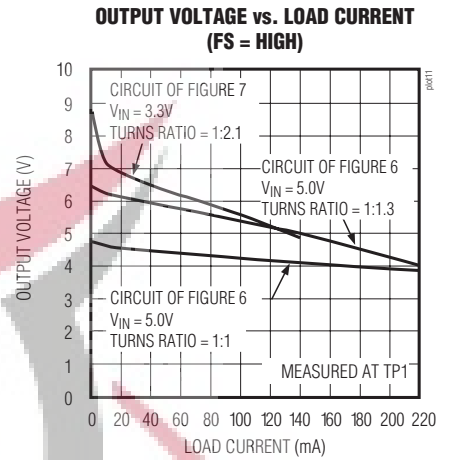
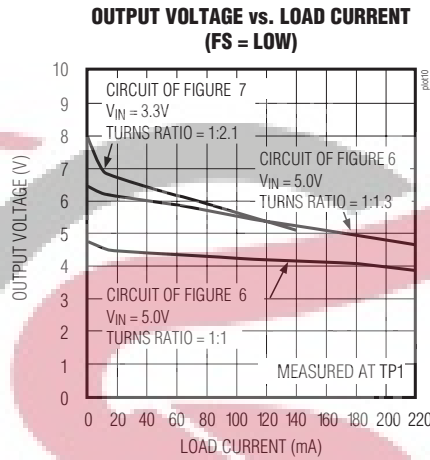
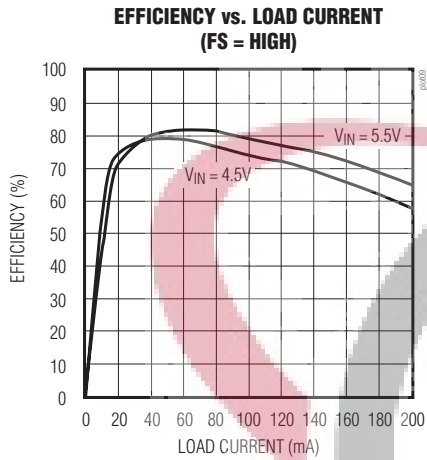

SWITCHING WAVEFORMS (TWO CYCLES)

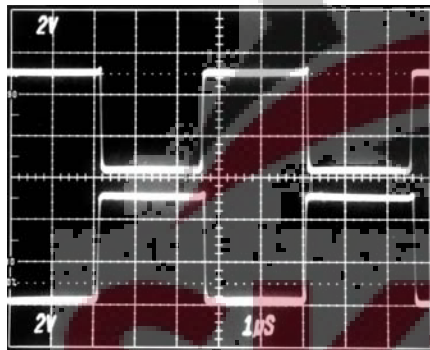

CIRCUIT OF FIGURE 1

SWITCHING WAVEFORMS (BREAK BEFORE MAKE)

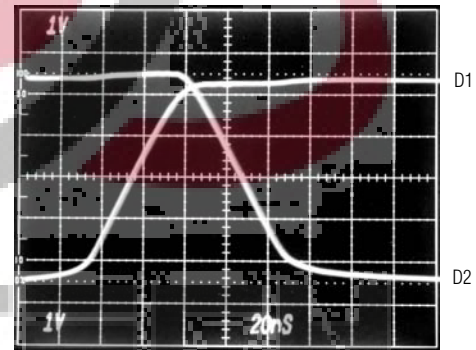

CIRCUIT OF FIGURE 1

TIME FROM SHUTDOWN TO POWER-UP

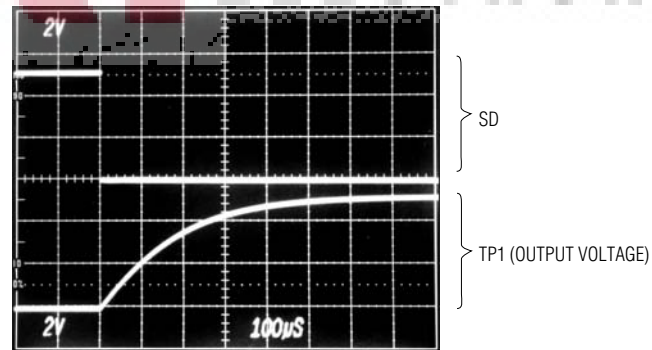

CIRCUIT OF FIGURE 6

Pin Configuration

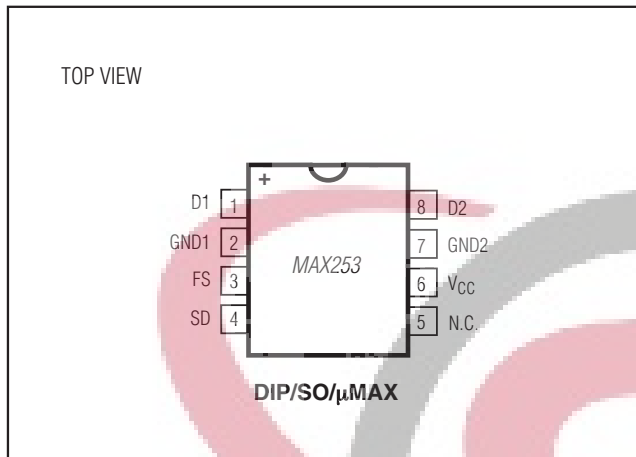

Pin Description

PIN	NAME	FUNCTION
1	D1	Open drain of N-channel transformer drive 1.
2	GND1	Ground. Connect both GND1 and GND2 to ground.
3	FS	Frequency switch. If FS = V _{CC} or open, switch frequency = 350kHz; if V _{FS} = 0V, switch frequency = 200kHz.
4	SD	Shutdown. Ground for normal operation, connect high for shutdown.
5	N.C.	Not internally connected.
6	V _{CC}	5V supply voltage.
7	GND2	Ground. Connect both GND1 and GND2 to ground.
8	D2	Open drain of N-channel transformer drive 2.

SKYTECH
ELECTRONIC

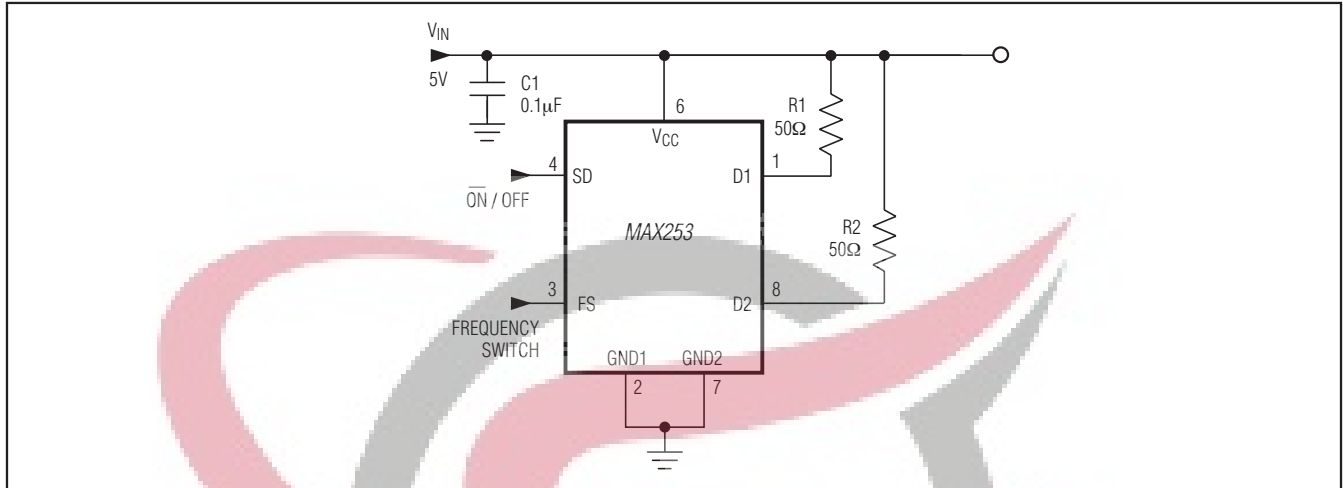

Figure 1. Test Circuit

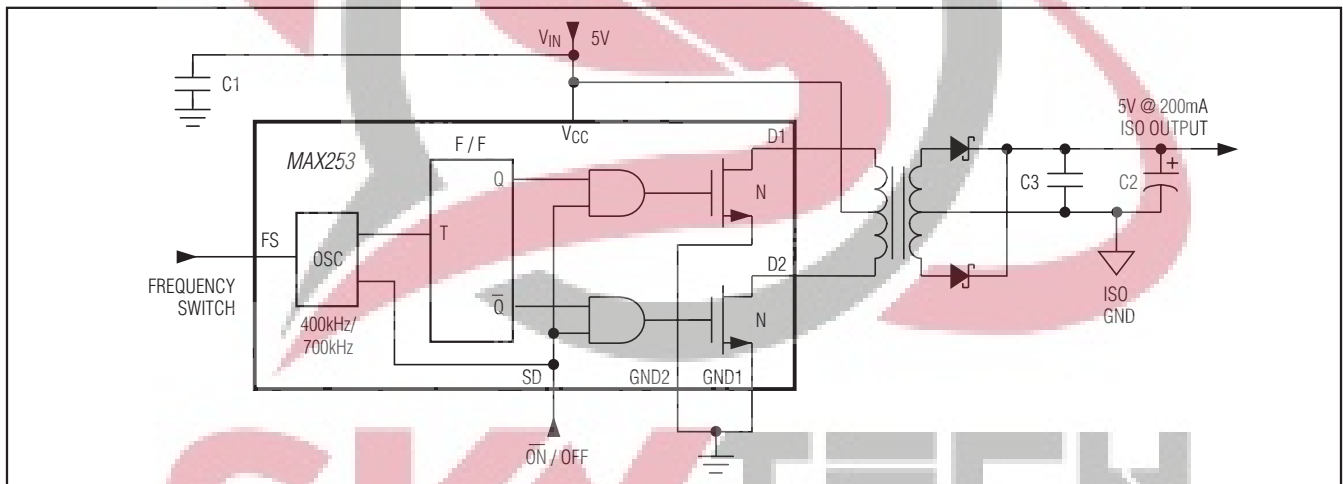

Figure 2. Block Diagram

Detailed Description

The MAX253 is an isolated power-supply transformer driver specifically designed to form the heart of a fully isolated RS-485 data interface. Completely isolated communications are obtained by combining the MAX253 with a linear regulator, a center-tapped transformer, optocouplers, and the appropriate Maxim interface product (as described in the *Isolated RS-485/RS-232 Data Interface* section).

The MAX253 consists of an RC oscillator followed by a toggle flip-flop, which generates two 50% duty-cycle square waves, out-of-phase at half the oscillator fre-

quency (Figure 2). These two signals drive the ground-referenced output switches. Internal delays ensure break-before-make action between the two switches.

Ground SD for normal operation. When high, SD disables all internal circuitry, including the oscillator and both power switches.

Pulling FS low reduces the oscillator frequency and lowers the supply current (see Supply Current vs. Temperature in the *Typical Operating Characteristics*). FS includes a weak pull-up, so it will be set to the high-frequency state if not connected.

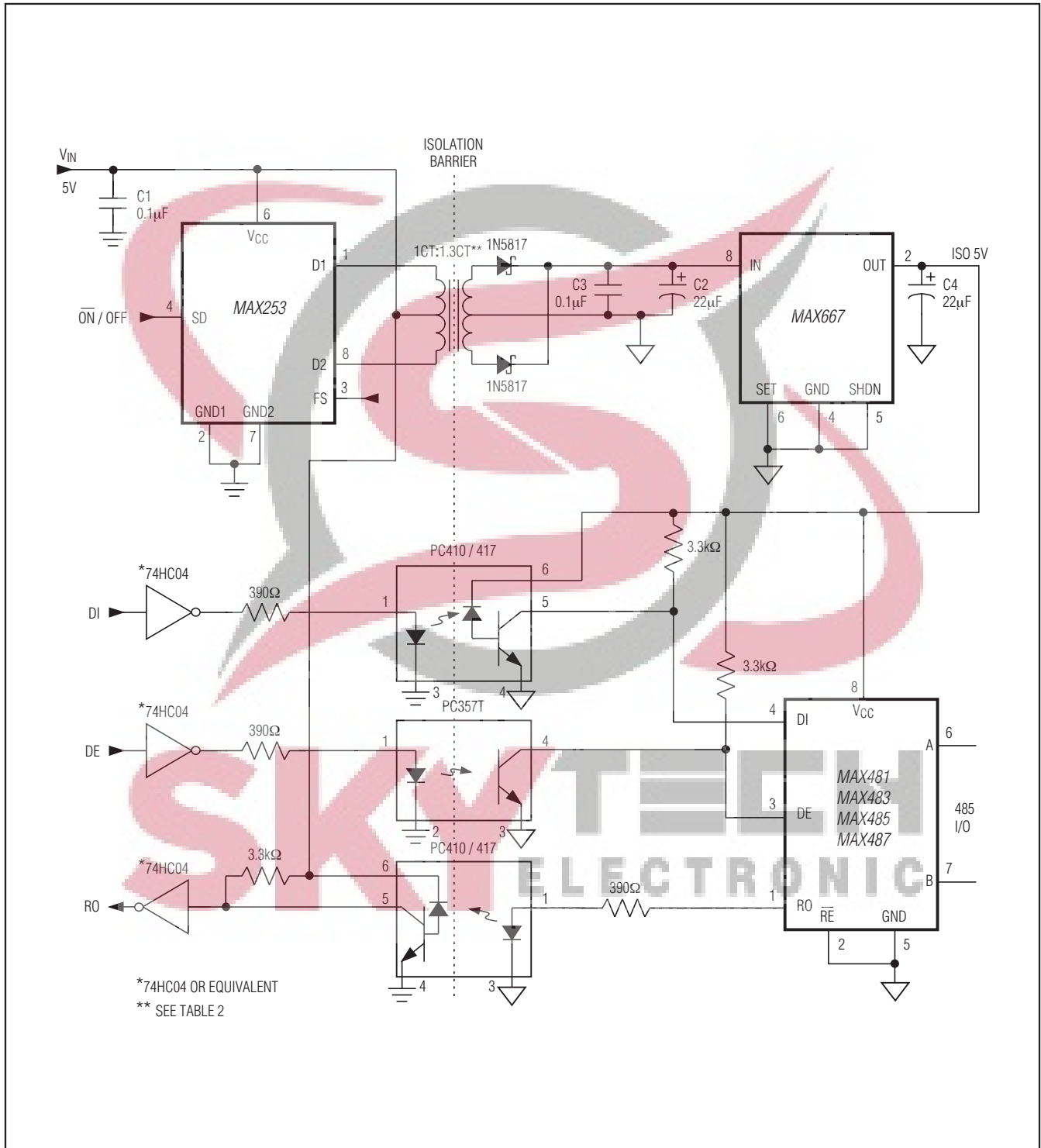

Figure 3. Typical RS-485 Application Circuit, 5V Configuration

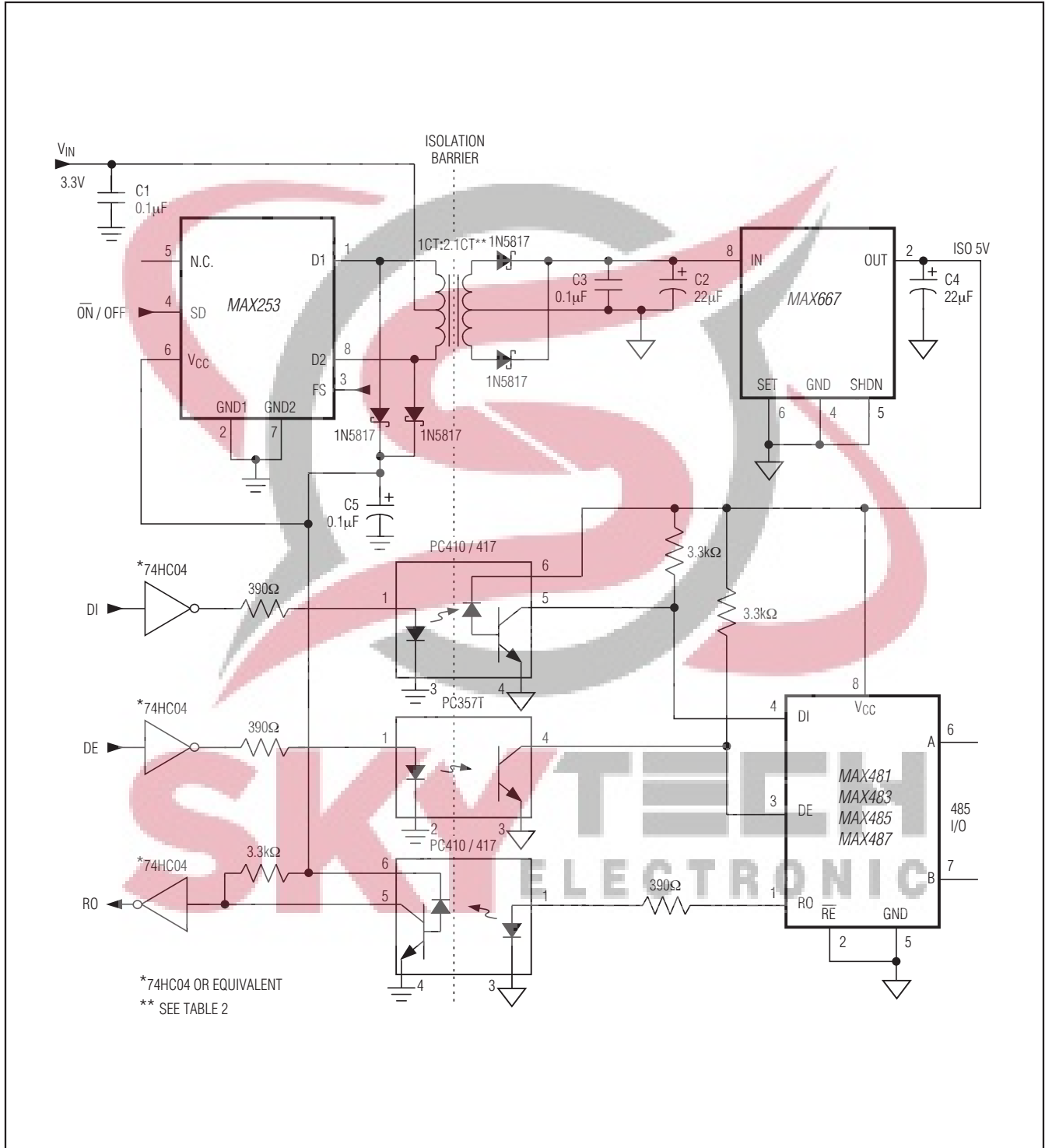

Figure 4. Typical RS-485 Application Circuit, 3.3V Configuration

Applications Information

Figures 3–5 are typical isolated RS-485/RS-232 data-interface circuits. These circuits withstand 1800V_{RMS} (1sec) and are intended for industrial communications and control applications where very high voltage transients, differential ground potentials, or high noise may be encountered.

Table 2 lists transformer characteristics for the applications of Figures 3–10. Some suggested manufacturers of transformers, transformer cores, and optocouplers are listed in Table 3, along with their respective phone and fax numbers.

Important layout considerations include:

- ◆ For maximum isolation, the “isolation barrier” should not be breached. Connections and components from one side should not be located near those of the other side.
- ◆ Since the optocoupler outputs are relatively high-impedance nodes, they should be located as close as possible to the Maxim interface IC. This minimizes stray capacitance and maximizes data rate.

Refer to the μ MAX package information for pin spacing and physical dimensions.

Isolated RS-485 Data Interface

The MAX253 power-supply transformer driver is designed specifically for isolated RS-485 data-interface applications. The application circuits of Figures 3 and 4 combine the MAX253 with a low-dropout linear regulator, a transformer, several high-speed optocouplers, and a Maxim RS-485 interface device. With a few modifications to these circuits, full-duplex communications can be implemented by substituting the MAX481/MAX485 with the MAX490/MAX491 (for data rates up to 2.5Mbps) or substituting the MAX483/MAX487 with the MAX488/MAX489 (for data rates up to 250kbps).

The data transfer rates of the application circuits in Figures 3 and 4 are critically limited by the optocouplers. Table 1 lists suggested optocouplers and the

appropriate Maxim interface device for data-transfer rates up to 2.5Mbps.

Refer to the MAX1480 data sheet for a complete isolated RS-485 solution in one package.

Isolated RS-232 Data Interface

The MAX253 is ideal for isolated RS-232 data-interface applications requiring more than four transceivers. The 1W power output capability of the MAX253 enables it to drive more than 10 transceivers simultaneously. Figure 5 shows the typical application circuit for a complete 120kbps isolated RS-232 data interface. The figure also shows how the Sharp PC417 optocouplers can be replaced by the lower-cost 4N25 devices to achieve data-transfer rates up to 9.6kbps.

For 3.3V operation, substitute the primary portion of Figure 5 with the circuit of Figure 7.

For applications requiring two transceivers or fewer, refer to the MAX250/MAX251 or MAX252 data sheet.

Isolated Power Supplies

The MAX253 is a versatile isolated power driver, capable of driving a center-tapped transformer primary from a 5V or a 3.3V DC power supply (Figures 6 and 7). The secondary can be wound to provide any isolated voltage needed at power levels up to 1W with a 5V supply, or 600mW with a 3.3V supply. Figure 6 shows a typical 5V to isolated 5V application circuit that delivers up to 200mA of isolated 5V power.

In Figure 7, the MAX253 is configured to operate from a 3.3V supply, deriving a “boost” V_{CC} for the MAX253 by connecting diodes to both ends of the transformer primary. This produces nearly double the input supply, and may be useful for other applications, as shown in Figure 4. The average current in each MAX253 switch must still be limited to less than 200mA, so the total power available is approximately 600mW.

Table 1. Optocouplers and RS-485 Interface ICs for Various Data Rates

DATA RATE	FULL DUPLEX RS-485 IC	HALF DUPLEX RS-485 IC	OPTOCOUPLER FOR DI / RO	OPTOCOUPLER FOR DE
250kbps	MAX488/MAX489	MAX483/MAX487	PC417*	PC357T*
2.5Mbps	MAX490/MAX491	MAX481/MAX485	PC410*	PC357T

* PC-Series Optocouplers, Sharp Electronics

USA Phone: (206) 834-2500

FAX: (206) 834-8903

Sharp Electronics, Europe GmbH

Germany Phone: (040) 2376-0

FAX: (040) 230764

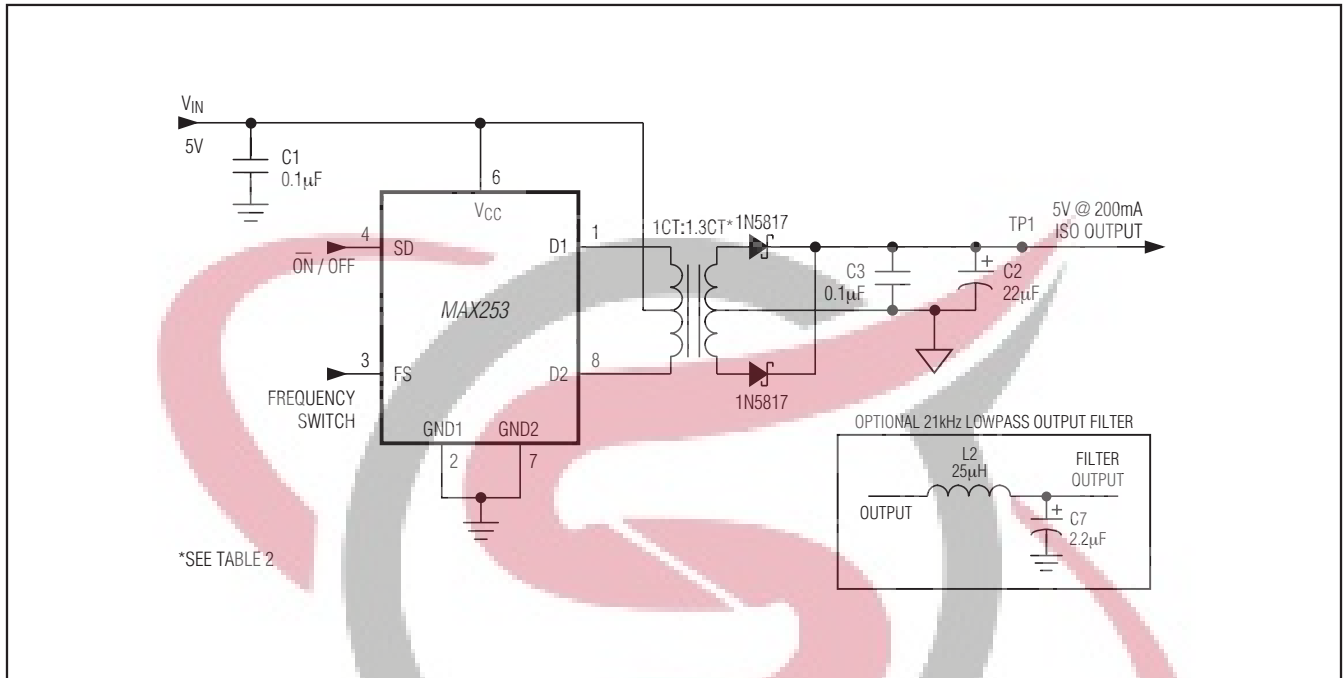

Figure 6. 5V to Isolated 5V Application Circuit

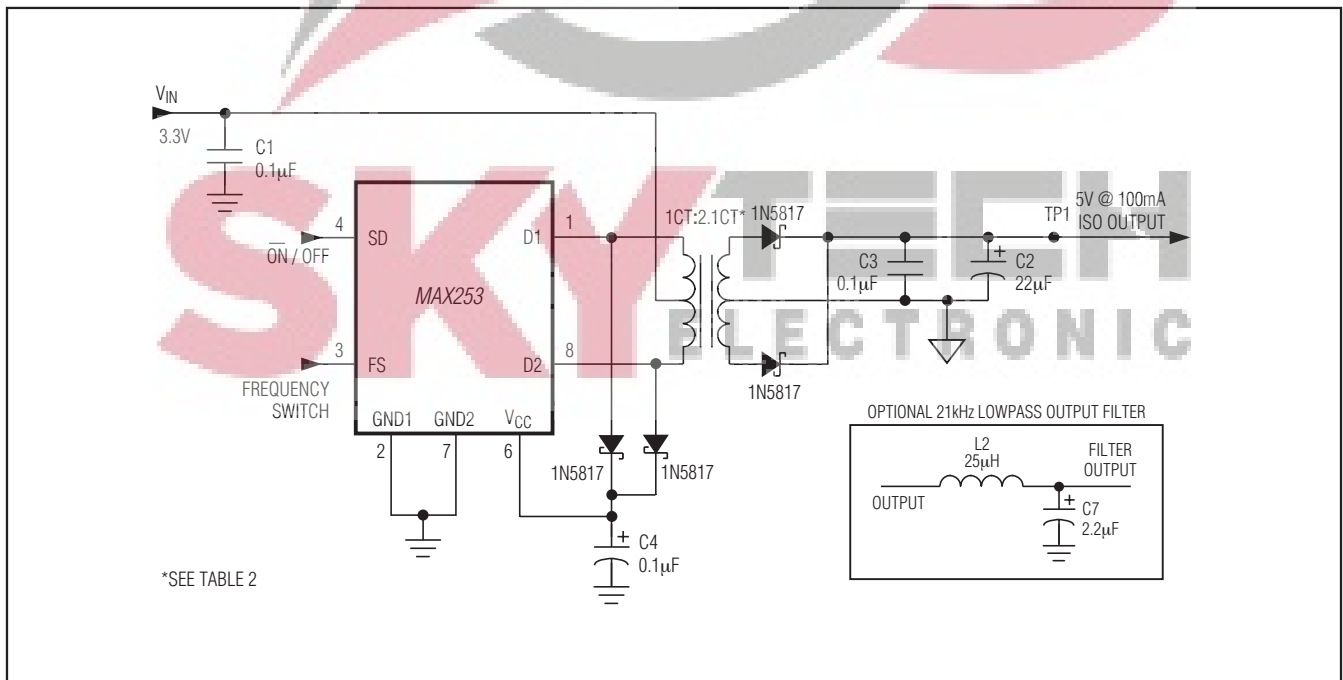

Figure 7. 3.3V to Isolated 5V Application Circuit

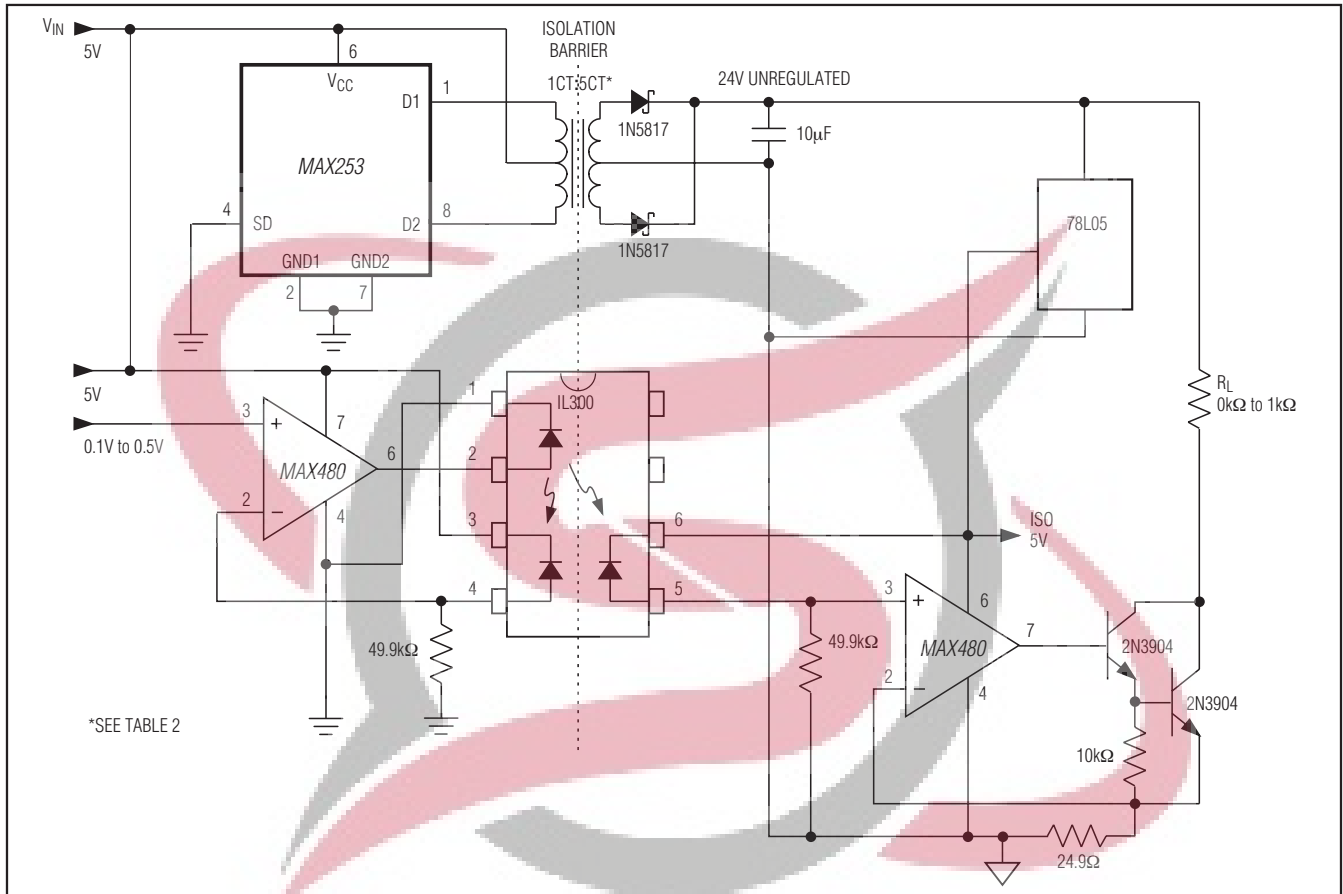

Figure 8. Typical 4mA to 20mA Application Circuit

Output-Ripple Filtering

A simple lowpass pi-filter (Figures 6 and 7) can be added to the output to reduce output ripple noise to approximately 10mVp-p. The cutoff frequency shown is 21kHz. Since the filter inductor is in series with the circuit output, minimize its resistance so the voltage drop across it is not excessive.

Isolated 4mA to 20mA Analog Interface

The 4mA to 20mA current loop is a standard analog signal range that is widely used in the process-control industry for transducer and actuator control signals. These signals are commonly referred to a distant ground that may be at a considerably higher voltage with respect to the local ground.

An analog signal in the range of 0.1V to 0.5V is applied to the first MAX480 to generate a signal current in the range of 20µA to 100µA. This low-level signal is transferred across the barrier by the Siemens IL300 linear optocoupler. This device is unique in that it corrects the dominant nonlinearity present in most optocou-

plers—the LED efficiency variation. The IL300 is really two optocouplers in the same package sharing the same LED; one detector is across the isolation barrier, the other is on the same side as the LED (Figure 8). The latter detector is used to generate a feedback signal identical to the signal on the isolated side of the barrier. The current signal transferred across the barrier is converted back to a voltage that matches the input in the 100mV to 500mV range. This voltage is then transformed to the final 4mA to 20mA current signal range by the second MAX480, Darlington stage, and the 20Ω resistor.

Isolated ADC

Almost any serial-interface device is a candidate for operation across an isolation barrier; Figure 10 illustrates one example. The MAX176 analog-to-digital converter (ADC) operates from 5V and -12V supplies, provided by the multiple-tapped secondary and linear regulators. If some additional isolated power is needed for signal conditioning, multiplexing, or possibly for a

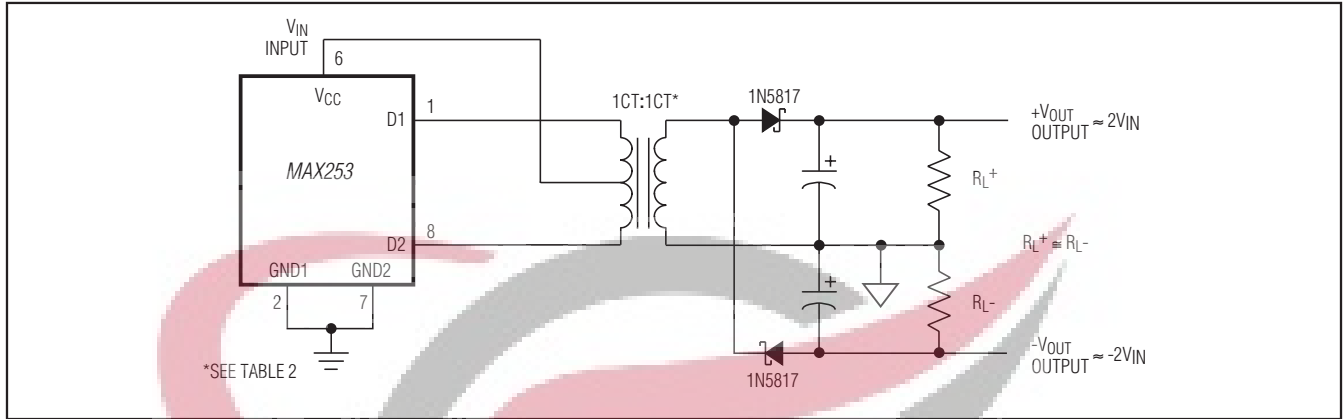

Figure 9a. Half-Wave Rectifier—Bipolar

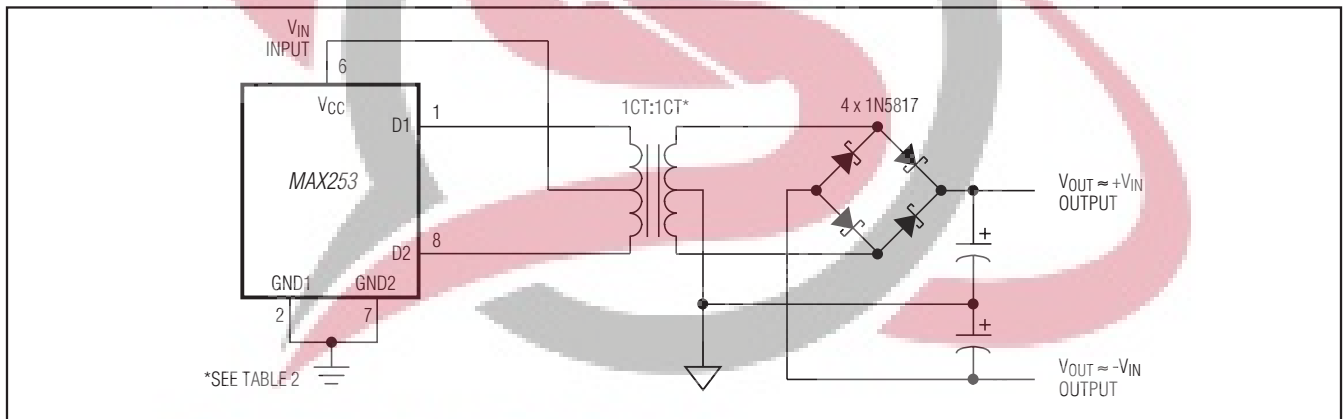

Figure 9b. Full-Wave Rectifier—Bipolar

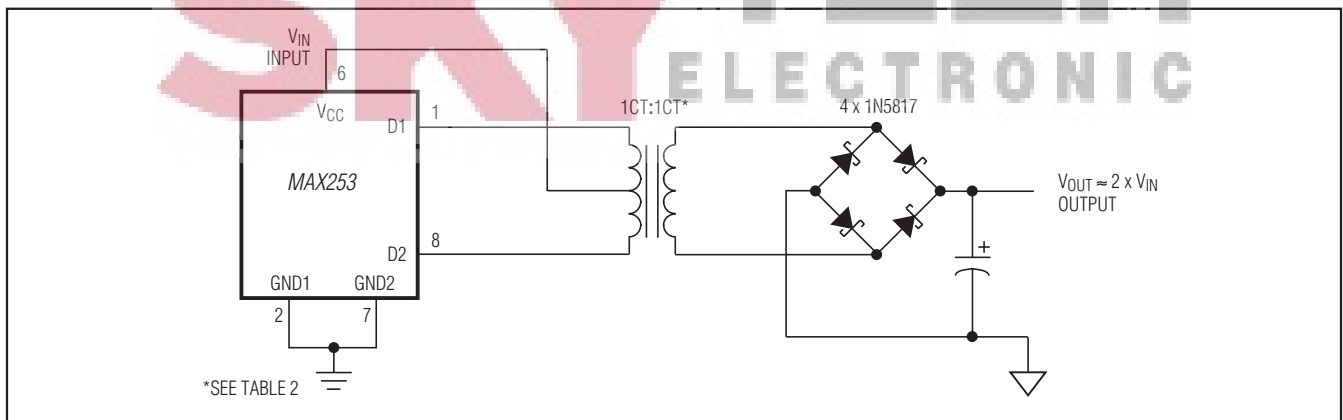

Figure 9c. Full-Wave Rectifier—Unipolar

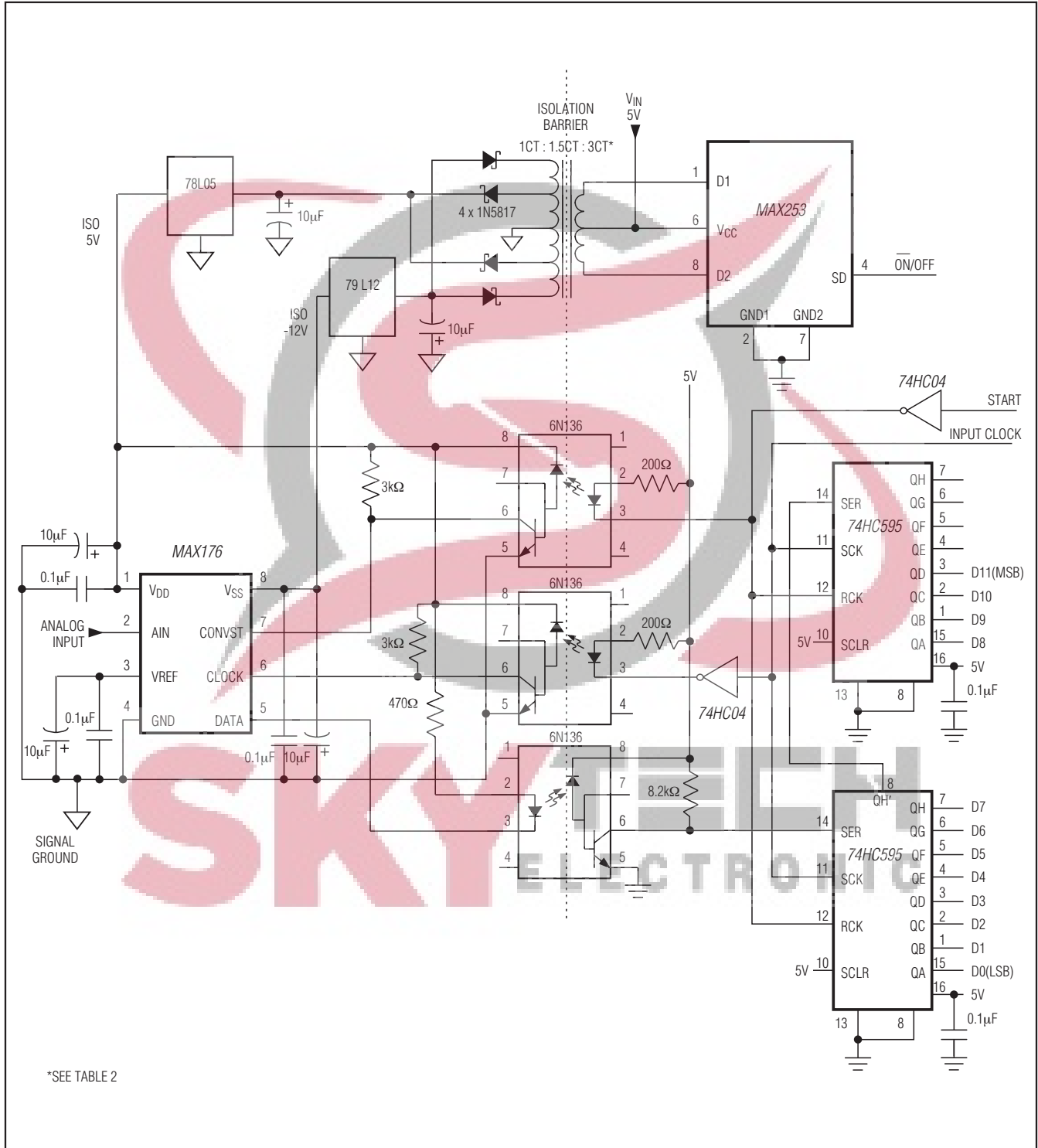

Figure 10. Typical Isolated ADC Application

sensor, an extra several hundred milliwatts could easily be supplied by the circuit, as shown. A 12V supply could be generated by adding two more diodes to the ends of the secondary, and a -5V supply could be generated by connecting additional diodes to the 1/4 and 3/4 tap points on the secondary. For 5V only applications, the MAX187 is recommended.

Component Selection

Transformer Selection

The transformer primary used with the MAX253 must be a center-tapped winding with sufficient ET product to prevent saturation at the worst-case lowest selected frequency. The MAX253's guaranteed minimum frequency with the FS pin held low is 150kHz, equating to a maximum period of 6.67 μ s. The required ET product

for half the primary is simply the product of the maximum supply voltage and half the maximum period. With FS connected high, the guaranteed minimum frequency is 250kHz, giving a maximum period of 4 μ s.

The secondary winding may or may not be center tapped, depending on the rectifier topology used. The phasing of the secondary winding is not critical. In some applications, multiple secondaries might be required. Half-wave rectification could be used, but is discouraged because it normally adds a DC imbalance to the magnetic flux in the core, reducing the ET product. If the DC load is imbalanced, full-wave rectification is recommended, as shown in Figure 9b.

The transformer turns ratio must be set to provide the minimum required output voltage at the maximum anticipated load with the minimum expected input volt-

Table 2. Typical Transformer Characteristics

CHARACTERISTIC		5V to \pm 10V	5V to 5V	3.3V to 5V	5V to 24V	5V to \pm 5V; \pm 12V
Figure		9a	2, 3, 5, 6	4, 7	8	10
Turns Ratio		1CT*:1	1CT:1.3CT	1CT:2.1CT	1CT:5CT	1CT:1.5CT:3CT
Typical Windings	Primary	44CT	44CT	28CT	44CT	44CT
	Secondary	44	56CT	56CT	220CT	66CT, 132CT
Primary ET Product	FS Low	18.3V- μ s	18.3V- μ s	12V- μ s	18.3V- μ s	18.3V- μ s
	FS High	11V- μ s	11V- μ s	7.2V- μ s	11V- μ s	11V- μ s

*CT = Center Tapped

Table 3. Transformer, Transformer Core, and Optocoupler Suppliers

TRANSFORMERS	TRANSFORMER CORES	OPTOCOUPERS
BH Electronics Phone: (507) 532-3211 FAX: (507) 532-3705	Philips Components Phone: (407) 881-3200 FAX: (407) 881-3300	Quality Technology Phone: (408) 720-1440 FAX: (408) 720-0848
Coilcraft Phone: (708) 639-6400 FAX: (708) 639-1469	Magnetics Inc. Phone: (412) 282-8282 FAX: (412) 282-6955	Sharp Electronics Phone: (206) 834-2500 FAX: (206) 834-8903
Coiltronics Phone: (516) 241-7876 FAX: (516) 241-9339	Fair-Rite Products Phone: (914) 895-2055 FAX: (914) 895-2629	Siemens Components Phone: (408) 777-4500 FAX: (408) 777-4983

age. In addition, include in the calculations an allowance for worst-case losses in the rectifiers. Since the turns ratio determined in this manner will ordinarily produce a much higher voltage at the secondary under conditions of high input voltage and/or light loading, be careful to prevent an overvoltage condition from occurring (see Output Voltage vs. Load Current in the *Typical Operating Characteristics*).

Transformers used with the MAX253 will ordinarily be wound on high-permeability magnetic material. To minimize radiated noise, use common closed-magnetic-path physical shapes (e.g., pot cores, toroids, E/I/U cores). A typical core is the Philips 213CT050-3B7, which is a toroid 0.190" in diameter and 0.05" thick. For operation with this core at 5.5V maximum supply voltage, the primary should have approximately 22 turns on each side of the center tap, or 44 turns total. This will result in a nominal primary inductance of approximately 832μH. The secondary can be scaled to produce the required DC output.

Diode Selection

The MAX253's high switching frequency demands high-speed rectifiers. Schottky diodes are recommended. Ensure that the Schottky diode average current rating exceeds the load-current level. The 1N5817

is a good choice for through-hole applications, and the NIEC* SB05W05C dual in an SOT-23 package is recommended for surface-mount applications. Use the higher frequency setting to reduce ripple.

Output Filter Capacitor

In applications sensitive to output-ripple noise, the output filter capacitor C2 should have a low effective series resistance (ESR), and its capacitance should remain fairly constant over temperature. Sprague 595D surface-mount solid tantalum capacitors and Sanyo OS-CON through-hole capacitors are recommended due to their extremely low ESR. Capacitor ESR usually rises at low temperatures, but OS-CON capacitors provide very low ESR below 0°C.

In applications where output ripple is not critical, a 0.1μF chip or ceramic capacitor is sufficient. Refer to Table 4 for suggested capacitor suppliers. Use the higher frequency setting to reduce ripple.

Input Bypass Capacitor

The input bypass capacitor C1 is not critical. Unlike switching regulators, the MAX253's supply current is fairly constant, and is therefore less dependent on the input bypass capacitor. A low-cost 0.1μF chip or ceramic capacitor is normally sufficient for input bypassing.

Table 4. Suggested Capacitor Suppliers

PRODUCTION METHOD	CAPACITORS
Surface Mount	Matsuo 267 series (low ESR) USA Phone: (714) 969-2491, FAX: (714) 960-6492 Sprague Electric Co. 595D/293D series (very low ESR) USA Phone: (603) 224-1961, FAX: (603) 224-1430 Murata Erie Ceramic USA Phone: (800) 831-9172, FAX: (404) 436-3030
High-Performance Through Hole	Sanyo OS-CON series (very low ESR) USA Phone: (619) 661-6835, FAX: (619) 661-1055 Japan Phone: 81-7-2070-1005, FAX: 81-7-2070-1174
Through Hole	Nichicon PL series (low ESR) USA Phone: (708) 843-7500, FAX: (708) 843-2798 Japan Phone: 81-7-5231-8461, FAX: 81-7-5256-4158

* Nihon Inter Electronics Corp.
USA Phone: (805) 867-2555
FAX: (805) 867-2556
Japan Phone: 81-3-3494-7411
FAX: 81-3-3494-7414

Chip Information

PROCESS: CMOS

Package Information

For the latest package outline information and land patterns (footprints), go to www.maximintegrated.com/packages. Note that a "+", "#", or "-" in the package code indicates RoHS status only. Package drawings may show a different suffix character, but the drawing pertains to the package regardless of RoHS status.

PACKAGE TYPE	PACKAGE CODE	DOCUMENT NO.
8 μ MAX	U8+1	21-0036
8 PDIP	P8+1	21-0043
8 SO	S8+4	21-0041
8 CDIP	J8-2	21-0045



Revision History

REVISION NUMBER	REVISION DATE	DESCRIPTION	PAGES CHANGED
0	2/94	Initial release	—
1	8/09	Deleted the MAX253EUA part number from the <i>Ordering Information</i> table	1
2	4/10	Added automotive qualified part number to the <i>Ordering Information</i> table	1
3	2/15	Added the <i>Benefits and Features</i> section	1



For pricing, delivery, and ordering information, please contact Maxim Direct at 1-888-629-4642, or visit Maxim Integrated's website at www.maximintegrated.com.

Maxim Integrated cannot assume responsibility for use of any circuitry other than circuitry entirely embodied in a Maxim Integrated product. No circuit patent licenses are implied. Maxim Integrated reserves the right to change the circuitry and specifications without notice at any time. The parametric values (min and max limits) shown in the Electrical Characteristics table are guaranteed. Other parametric values quoted in this data sheet are provided for guidance.